



# **Nanolumens<sup>®</sup>**

## **Installation Manual & User's Guide**

All In One Display

Captivate Series:

NLID-20004

NLID-20008

NLID-20009

Revision 2.0

September 21, 2022

**Nanolumens**

**5390 Triangle Pkwy NW #300**

**Peachtree Corners, GA 30092**

**855-465-8895**

The information herein is confidential and shall not be divulged to a third party  
without the prior written permission of Nanolumens.

This document holds Copyright 2022 ©Nanolumens, All rights reserved.

## Authority

	Name	Position	Date
<b>Author</b>	Kevin O'Quinn	Technical Writer	4/20/2022
<b>Editor</b>	Kevin O'Quinn	Technical Writer	9/21/2022
<b>Reviewed</b>			
<b>Released</b>	Kevin O'Quinn	Technical Writer	9/21/2022
<b>Document</b>	NanolumensCaptivateAIOInstallation_R11_20220920		

## Record of Revisions / Document History

This document contains 50 pages.

Revision	Date	Effected Sections	Comments	Author/Editor
0	4/20/2022	All	Initial Draft	K. O'Quinn
0.1	4/25/2022	5.2.3	Undated Draft	K. O'Quinn
0.2	4/26/2022	All	Undated Draft	K. O'Quinn
0.3	4/27/2022	5.2.3	Updated Draft	K. O'Quinn
0.4	5/10/2022	5.2, 7.1	Updated Draft	K. O'Quinn
1.0	6/05/2022	8.1	Update and Release	K. O'Quinn
1.1	9/20/2022	8.3.3	Update Packaging Instructions	K. O'Quinn
2.0	9/21/2022	All	Final Release	K. O'Quinn

## Source

This manual was created from the source documents:

- Captivate AIO Installation Manual\_DEC 2 UPDATE (1).pdf
- Captivate-Specs-Sheet\_3.1.22
- Cleaning a NanoLumens Display
- QSTECH LED Integrated LED Display Installation Manual-Plus(ODM)
- QSTECH LED Integrated LED Display User Manual-Plus(ODM)
- QSTECH CRN PCON 600 Product Specification
- QSTECH 3-in-1 board introduction-2021
- Nixel Flex-Spec Sheet\_3.1.22
- 180 System connect Diagram 110v
- 180 System connect Diagram 220v

---

# Table of Contents

- Installation Manual ..... 1**
- & User’s Guide..... 1**
- 1 Purpose..... 5**
- 2 Safety Concerns ..... 5**
- 2.1 Safety Notices .....5
- 2.1.1 Warning .....5
- 2.1.2 Caution.....5
- 2.1.3 Note .....6
- 2.2 General Safety.....6
- 2.2.1 Electrocution.....6
- 2.2.2 Heavy Object.....6
- 2.2.3 Falling Object .....6
- 2.2.4 Electrostatic Discharge.....6
- 2.2.5 Fragile Equipment .....7
- 3 Installation Specifications ..... 7**
- 3.1 Voltage .....7
- 3.2 Ventilation.....7
- 3.3 Weight.....7
- 3.4 Size .....7
- 4 Infrastructure..... 7**
- 5 Installation..... 8**
- 5.1 Preparation .....8
- 5.2 Install the Mounting Structure .....9
- 5.2.1 Install the Hanging Bars .....9
- 5.2.2 Assemble the Display .....14
- 5.2.3 Assemble the Lower Side Frame .....18
- 5.2.4 Signal Cable Connections .....27
- 5.2.5 Install the LED Modules .....28
- 5.2.6 Install the Edgings & Frame Covers.....31
- 6 Functional Description ..... 34**
- 6.1 Power Supply .....34
- 6.2 Controller .....34
- 6.2.1 Video Card .....34
- 6.2.2 Sending Card .....34

---

- 6.3 Cabinets ..... 34
  - 6.3.1 Power Converter ..... 34
  - 6.3.2 Hub ..... 34
  - 6.3.3 Receiver Card ..... 34
  - 6.3.4 Nixel ..... 34
- 6.4 Speakers ..... 34
- 7 Troubleshooting ..... 37**
  - 7.1 Simple Troubleshooting ..... 37
    - A. Part of the display doesn't light up after power on..... 37
    - B. The indicator doesn't work. .... 37
    - C. No image is displayed after connecting to the computer with an HDMI cable.. .... 37
  - 7.2 Intermediate Troubleshooting ..... 37
    - A. No panels work. .... 37
    - B. All of or part of a column of panels does not work (others do work) ..... 38
- 8 Servicing and Support ..... 39**
  - 8.1 Cleaning ..... 39
  - 8.2 Warranty Returns..... 39
  - 8.3 Replacement of Parts ..... 40
    - 8.3.1 Adapter Board Removal ..... 40
    - 8.3.2 Adapter Board Installation ..... 42
    - 8.3.3 Module Removal..... 43
    - 8.3.4 Module Installation..... 47
- 9 Acknowledgements..... 50**
  - 9.1 General..... 50
  - 9.2 IPR Declaration:..... 50
  - 9.3 About NanoLumens..... 50

## 1 Purpose

The purpose of this manual is to provide instructions for the initial installation and setup of the Nanolumens Captivate All In One (AIO) Display. Additional information is provided to assist in troubleshooting and acquisition of replacement parts.

## 2 Safety Concerns

Some of the procedures in this manual are preceded by warnings/cautions regarding potential hazards in handling this equipment. These warnings/cautions should be carefully read and understood before proceeding. Failure to observe these precautions may result in serious injury to personnel performing the work and/or bystanders. The key hazards for this equipment are as follows:

Electrical - The electrical equipment described in this section operates at moderate voltages. Personnel should closely observe all generally prescribed cautions and warnings before performing any work.

Location – Special caution should be taken when accessing or servicing equipment mounted on a vertical surface or suspended from overhead.

Weight – To prevent possible personal injury when attempting to remove or install equipment, adequate support of a lifting device or additional personnel must be used to prevent the equipment from falling. Personnel's failure to heed these warnings could result in injury or damage to the equipment.

### 2.1 Safety Notices

Warnings, Cautions, and Notes emphasize dangerous or important points in the associated text. For the purpose of this document, the use of Warnings Cautions and Notes are defined as follows

#### 2.1.1 Warning



Figure 1

A Warning indicates a hazardous situation which, if not avoided, could result in death or serious injury. Warnings will be preceded by the banner shown in Figure 1 and will be formatted in red, all caps and bold to stand out.

#### 2.1.2 Caution



Figure 2

A Caution indicates a hazardous situation, which if not avoided, could result in minor or moderate injury or damage to equipment. Cautions will be preceded by the banner shown in Figure 2 and will be formatted in bold to stand out.

### 2.1.3 Note



Figure 3

A Note is used to highlight an essential operating or maintenance procedure, condition or statement which does not relate to personal injury or damage to equipment. Notes will be preceded by the banner shown in Figure 3 and will be formatted in italicized to stand out.

## 2.2 General Safety

### 2.2.1 Electrocutation



**POTENTIAL FOR ELECTRIC SHOCK. THIS PRODUCT USES 120 – 240 V<sub>AC</sub>. TAKE APPROPRIATE MEASURES WHEN WORKING AROUND ELECTRICITY.**

The Nanolumens AIO is an electronic device. While not drawing on high voltage, this product nonetheless is subject to the same hazards and precautions as any other electronic device.

### 2.2.2 Heavy Object



**POTENTIAL FOR INJURY. UTILIZE LIFTING DEVICES OR GET ASSISTANCE WHEN LIFTING HEAVY OBJECTS.**

Some components of the AIO may possess significant weight and a person can be subject to injury when trying to lift these components. Additionally, massive objects in motion can impact with crushing force. Get mechanical or human assistance when moving heavy objects.

### 2.2.3 Falling Object



**POTENTIAL FOR INJURY OR DEATH. TAKE MEASURES TO MAKE SURE ITEMS MOUNTED ON VERTICAL SURFACES OR SUSPENDED FROM OVERHEAD ARE SECURE IN PLACE WHEN WORKING AROUND THEM.**

Any object which is mounted on a vertical surface or suspended from overhead is subject to gravity and may fall until it is securely mounted. Always maintain control of these items until the mounting is complete.

### 2.2.4 Electrostatic Discharge



**Potential Damage to Circuits. Always use grounding straps when handling circuit boards or other semiconductors.**

Circuit Boards and Semiconductors are subject to damage from Electrostatic Discharge. Use anti-static packaging, proper grounding techniques and anti-static straps and tools when working with circuit boards and other semiconductors.

### 2.2.5 Fragile Equipment



**Potential Damage to LEDs. Do not store or transport the display in a face-down orientation that places the weight of the display on the LEDs.**

LEDs are fragile and are not designed to support any weight. Do not place any pressure on the LEDs either in handling the display or in storage or transport. This could cause damage to the LEDs requiring return to Nanolumens for repair or replacement.

## 3 Installation Specifications

### 3.1 Voltage

- NLID-20004: 1 x 120 V<sub>AC</sub> circuits
- NLID-20008: 2 x 120 V<sub>AC</sub> circuits
- NLID-20009: 2 x 120 V<sub>AC</sub> circuits

### 3.2 Ventilation

Sufficient air space must be present to allow for convective cooling. The temperatures should not be below 32°F (0°C) and not above

### 3.3 Weight

- NLID-20004: 255 lbs (115 kg)
- NLID-20008: 365 lbs (165 kg)
- NLID-20009: 474 lbs (215 kg)

### 3.4 Size

- NLID-20004: 105.44" x 64.18" x 2.0" (2678 mm x 1630 mm x 50.8 mm)
- NLID-20008: 131.66" x 78.90" x 2.0" (3344 mm x 2004 mm x 50.8 mm)
- NLID-20009: 157.89" x 93.67" x 2.0" (4010 mm x 2379 mm x 50.8 mm)

## 4 Infrastructure

This section details the necessary supporting infrastructure for the installation..

Before beginning verify that

- sufficient power will be available for the operation of the display and its supporting equipment.
  - For the NLID-20004, a single dedicated 120V, 20A circuit is required.
  - For the NLID-20008 or NLID-20009, two separate 120V, 20A dedicated circuits is required.
- mounting space is available, planed (flat) and the load-bearing mounting surface or hanging anchor is stressed to support the display.



*If the mounting surface (wall) is glass, marble, porcelain or a hollow wall, additional measures may be needed during installation.*

## 5 Installation



Figure 4



**Potential Damage to Equipment. Installation of the Captivate All In One Display should only be performed by an approved Nanolumens Technician.**

### 5.1 Preparation

1. Review Location to make sure supporting infrastructure is present. For requirements, see Section 3.
  - Voltage
  - Environment is free from problems (high humidity, salt air, poor circulation)
  - Data
2. Review Inventory to make sure all parts and tools are present. For requirements, see Section 4.
  - Parts List
  - Tools List
3. Review Mounting configuration and surfaces. For requirements, see Section 4.
4. Verify dimensions, Flatness, Stress/Load-bearing capability.



5. Verify sufficient ventilation will be present after install.

5.2 Install the Mounting Structure

This section addresses the installation of the mounting structure and is limited to penetration of the load-bearing wall, hanging and/or mounting on a vertical bracket.



**POTENTIAL FOR INJURY OR DAMAGE. UNTIL SECURELY IN PLACE, OBJECTS BEING MOUNTED ON A VERTICAL SURFACE, ARE SUBJECT TO FALL IF NOT HELD IN PLACE. MAINTAIN A FIRM GRIP ON THE ITEMS BEING MOUNTED UNTIL THE MOUNTING IS COMPLETE.**



*For wall mounting, the wall should be a load-bearing structure. Installation on special wall structures such as glass, marble, porcelain or hollow walls may require special installation with additional steps.*



*Nanolumens assumes on responsibility and bears no liability for any potentially hazardous installation designated by the client or third party nor any damage to other items caused byu the use of non-standard Nanolumens mounting devices or hardware.*

5.2.1 Install the Hanging Bars

This section covers the installation of the Hanging Bars..



*For the purpose of example, the NLID-20004 model is used. When mounting for the NLID-20008 or NLID-20009, make the required adjustments in measurements and equipment.*

6. Determine the mounting positions for the upper and lower hanging bars according to the site environment and the height of the screen above the ground. Use a level gauge to ensure that the bars will be horizontal.
7. Connect Upper Hanging Bar 1 to Upper Hanging Bar 2 using Connector (see Figure 5). Fit Hanging Bar 1 end to end with Hanging Bar 2 and use 6 M5x16 countersunk screws to preassemble the Hanging Bar. Do this for the Upper Hanging Bar and the Lower Hanging Bar

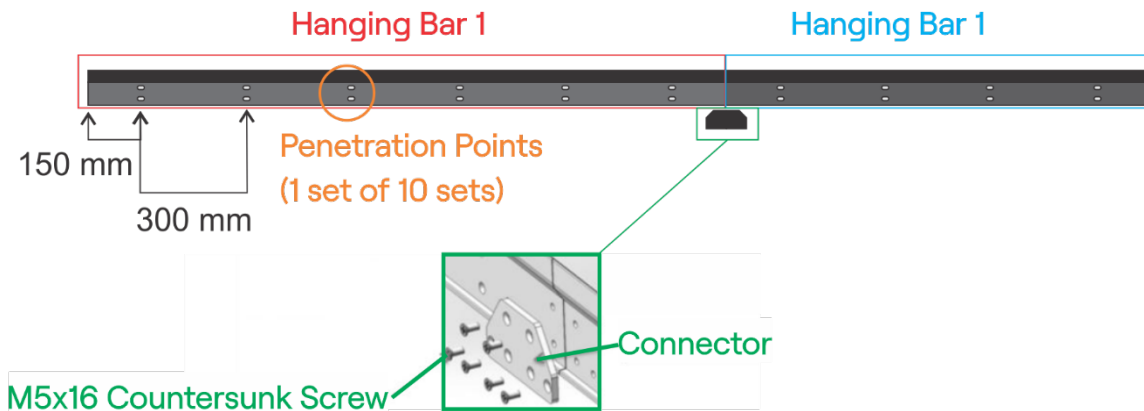

Figure 5



**NOTICE**

The immediately following steps refer to mounting on a solid surface such as a wall.

If mounting to a rolling or freestanding bracket, skip ahead to step 15.

8. Using the preassembled Upper and Lower Hanging Bars and a level gauge, determine the Penetration Points (punching positions) and mark the spots. Figure 5 shows the spacing and locations of the Penetration Points.
9. Use a penetrating tool to make a 10 mm hole at each of the Penetration Points on each Hanging Bar.
10. Install an M8x80 expansion bolt (see Figure 6) into each of the holes created in step 9. Tighten until the bolt is firmly in place and does not pull out.



Figure 6

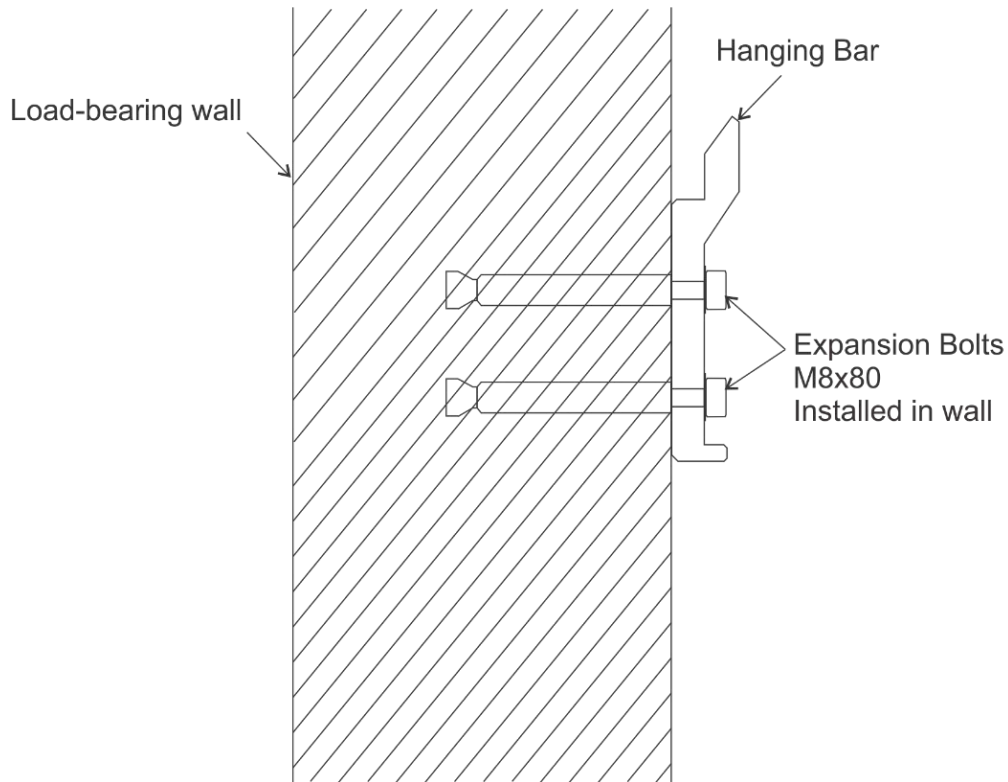

Figure 7

11. Remove the center bolts from each of the the holes created in step 9.
12. Place the Upper Hanging Bar in position over the holes and insert a bolt through each hole in the Upper Hanging Bar and into the wall as shown in Figure 7. Screw the bolt all the way in until tight.
13. Repeat step 12 for the Lower Hanging Bar.
14. Verify proper placement of the Hanging Bars. Loosen the expansion bolts, adjust the bars and retighten the expansion bolts if necessary.
  - a. Use a level gauge to verify that the Hanging Bars are level.
  - b. Use a tape measure to verify that the Hanging Bars are properly positioned and spaced.

**NOTICE**

*If the display is not to be mounted on a free-standing or rolling bracket, Exit this procedure at this point..*

15. Mount the Hanging Bars (upper and lower) to a free-standing or rolling bracket (120" or 150"). Use 16 sets of M8x60 bolts, flat washers and nuts as shown in Figure 8.

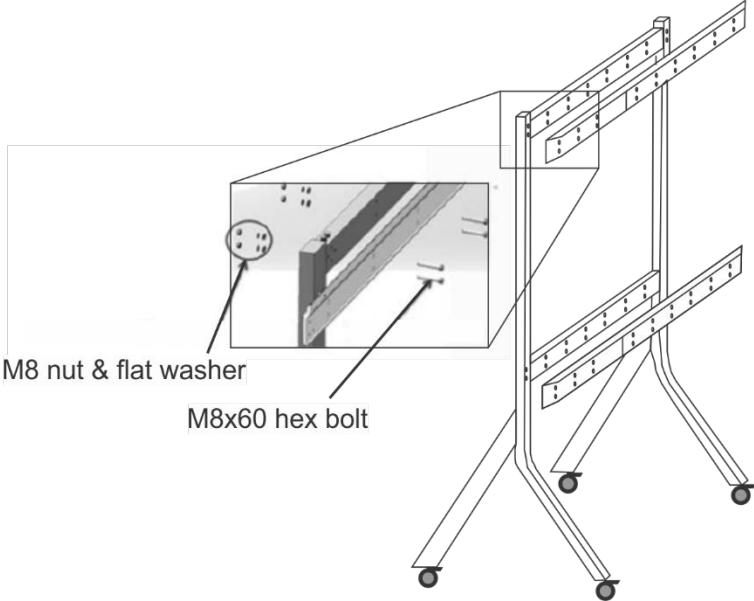

Figure 8

## 5.2.2 Assemble the Display

This section covers the Assembly of the Display.

### NOTICE

*For the purpose of example, the NLID-20004 model is used. When mounting for the NLID-20008 or NLID-20009, make the required adjustments in measurements and equipment.*

### NOTICE

*The integrated display is delivered with the panels joined into a column according to their numbers. A total of four columns are joined.*

1. Unpack and preposition the individual columns (see Figure 9).



Figure 9

2. Install the Hook Plates on the column (see Figure 10).

- a. Refer to the measurements made for the Hanging Bars and identify the individual Panels on which the Hook Plates will be mounted.
- b. Use two M8x25 Hex-head bolts and flat metal washers (A) to mount the Hook Plates (B) to the identified Panels. Tighten to fit.

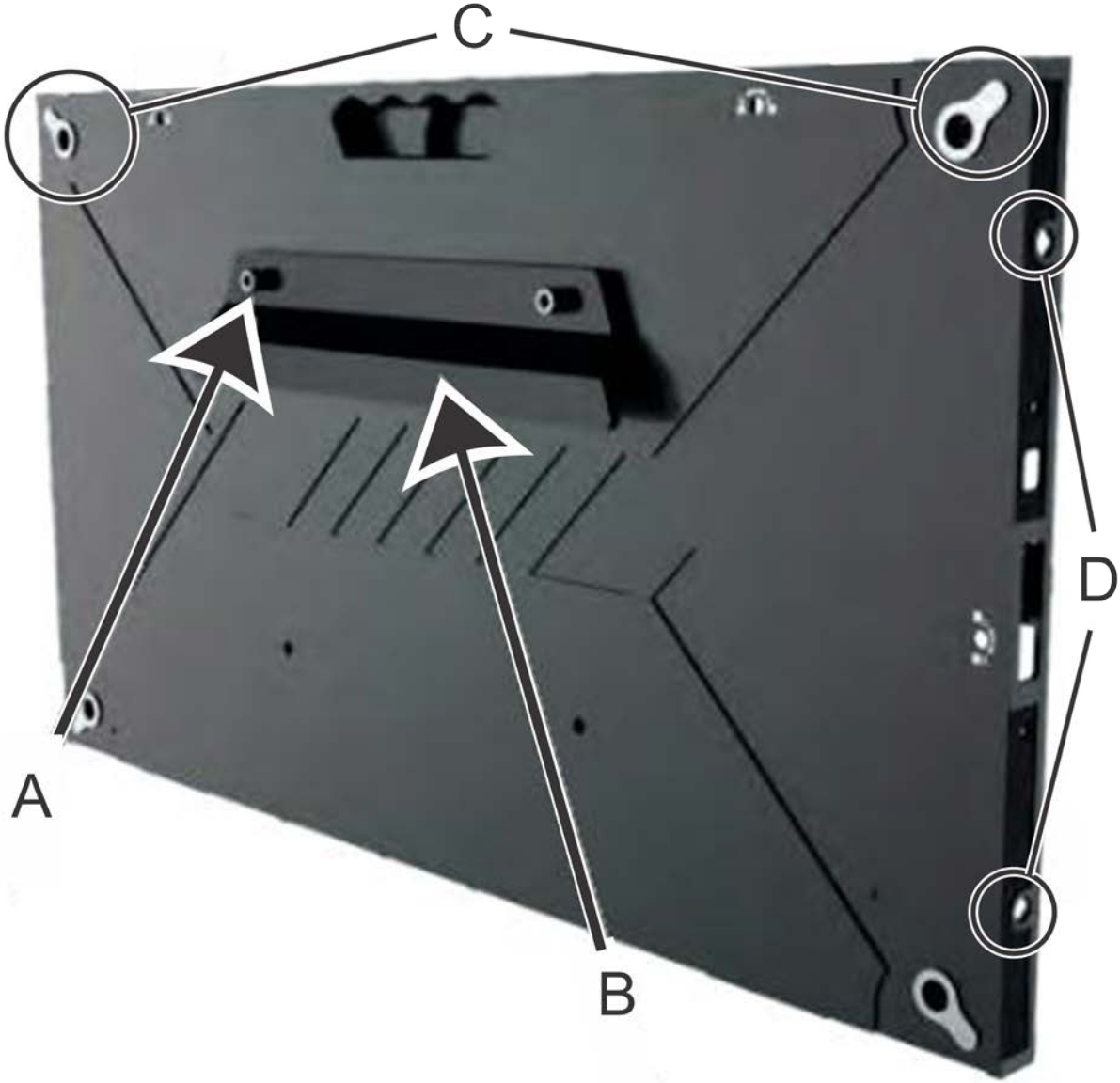

Figure 10

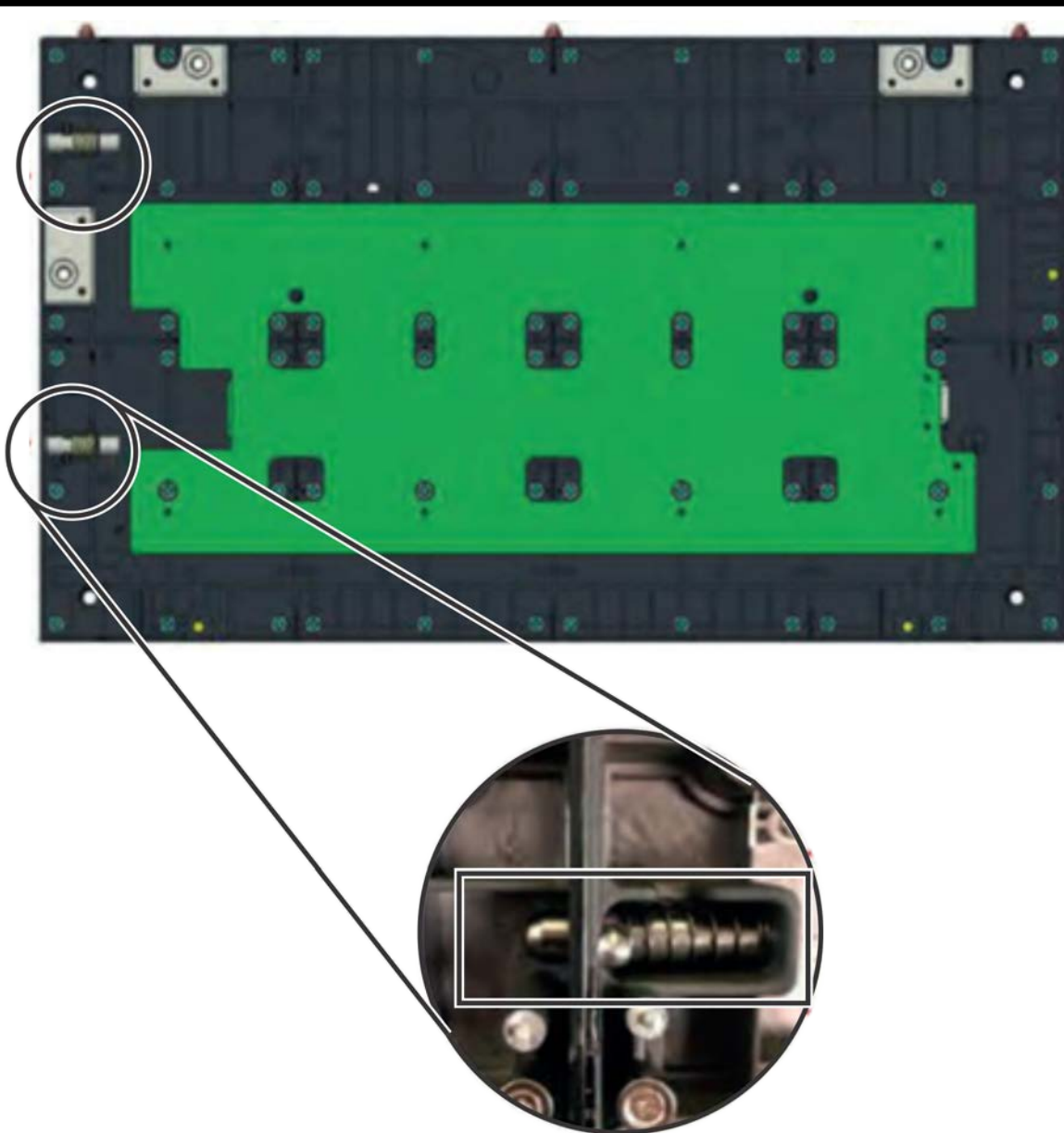

Figure 11

3. When individual columns are complete, hang them on the Hanging Bar (Figure 5) starting with the center column (see Figure 12 & Figure 13) and adding additional columns to either side moving outward. Place columns in position next to each other with the spring latches of one column aligned to the holes of the adjacent column (see Figure 11).
4. Remove the uppermost Locating Pins (C in Figure 10) from the top panels and the Spring Locking Pins (D) from the outer side of the leftmost column as seen looking from the front.
5. Latch the columns in place by rotating the locking cams, bottom pair first, then top



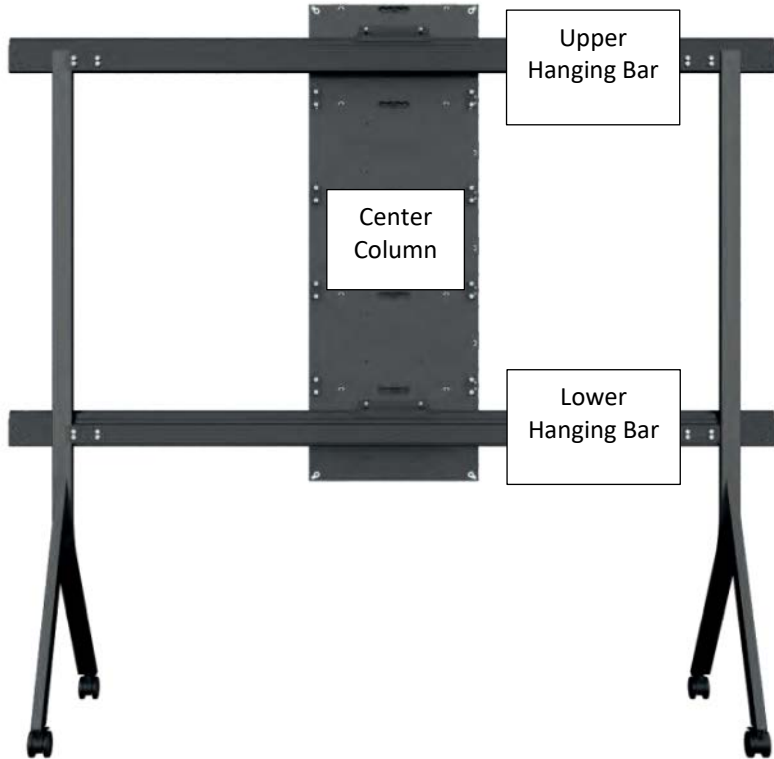

Figure 12: Viewed from back

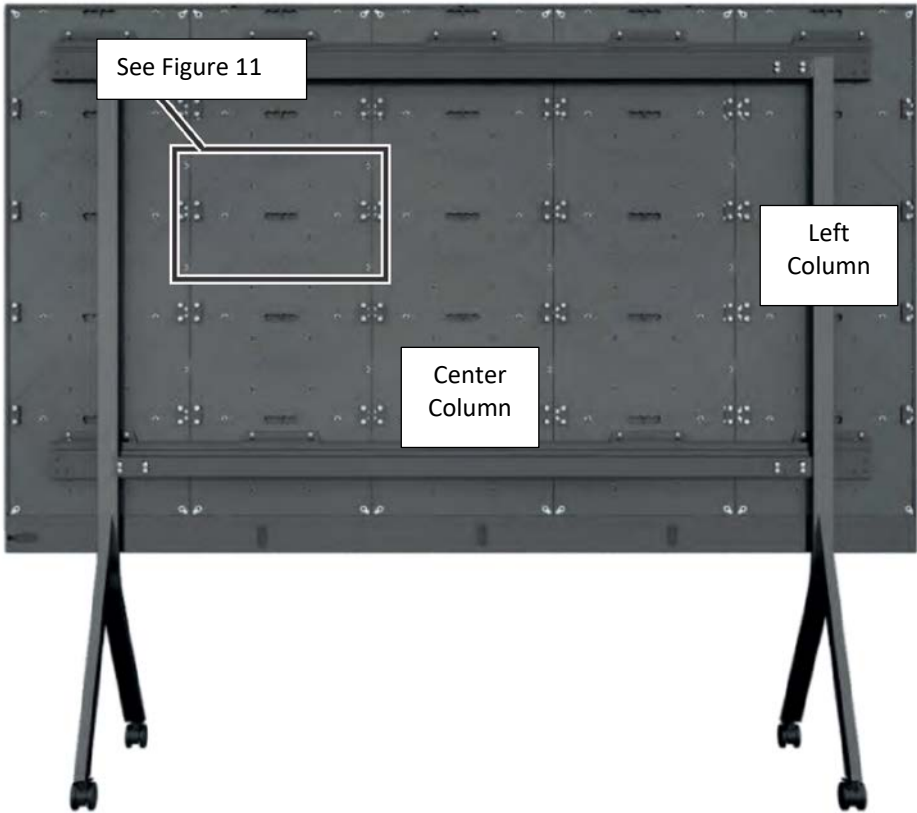

Figure 13: Viewed from back

6. Use a screwdriver to secure the upper edging across the top of each column.

### 5.2.3 Assemble the Lower Side Frame

The Lower Side Frame Assembly is made up of Lower Frame 1 and Lower Frame 2 connected by the Connecting Plate as shown in Figure 14.

**NOTICE**

*For the purpose of example, the NLID-20004 model is used. When mounting for the NLID-20008 or NLID-20009, make the required adjustments in measurements and equipment.*

**NOTICE**

*For the purpose of orientation, “left” and “right” are determined from the position of standing in front of and facing the display..*

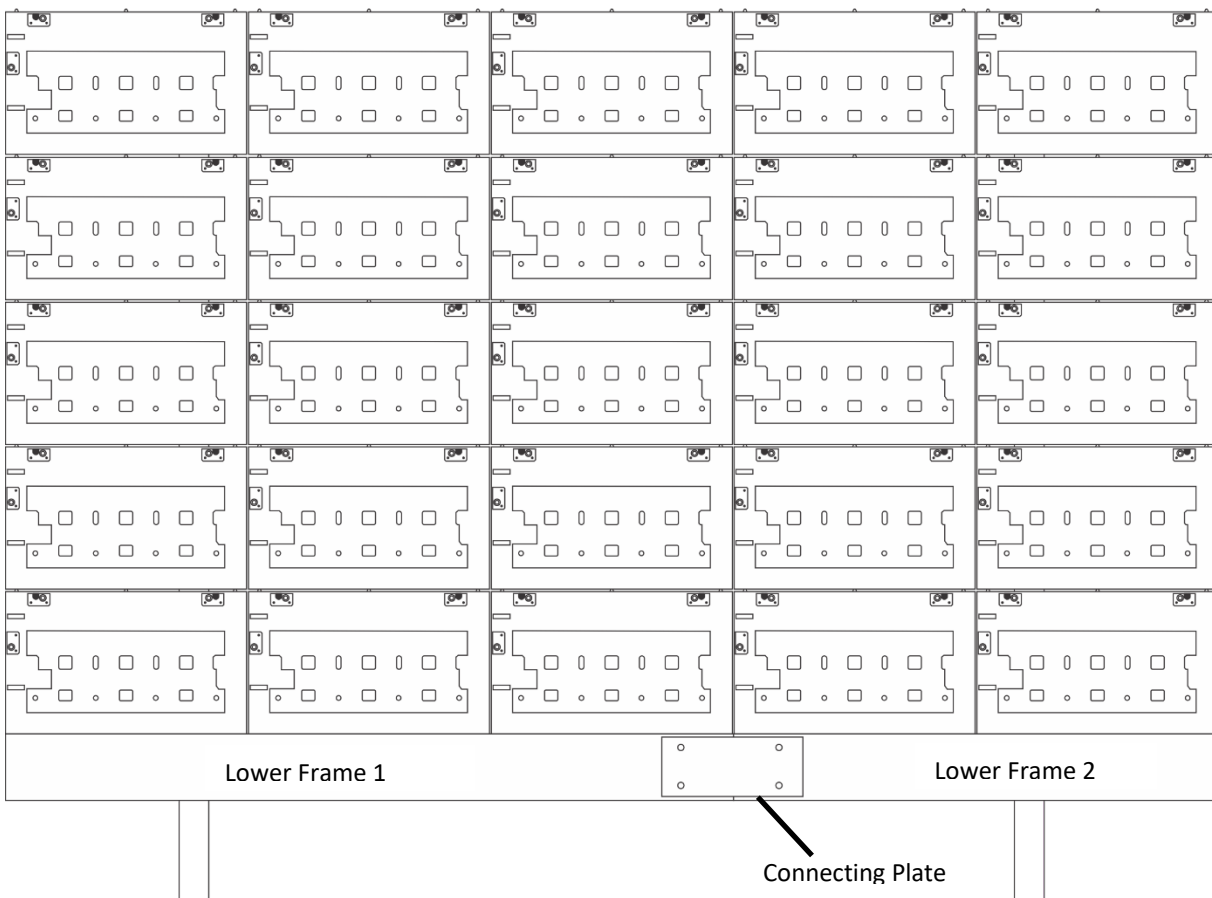

Figure 14

**NOTICE**

*Do not mount the Connecting Plate on the back of the Lower Frame 1 and Lower Frame 2. The Connecting Plate fits inside the Lower Frame Assembly.*

1. Place the Lower Frame 1 and Lower Frame 2 end to end and connect together with the Connecting Plate. The Connecting Plate fits inside the Lower Frame 1 and Lower Frame 2 and fastnes the two Lower Frames together using four M3x6 Screws. Tighten to fit. The two Lower Frames should be fastened firmly together.

2. Mount the Lower Frame Sound Bar in place beneath the lowest row of panels as shown. The Sound Bar locks in place using rotary hook locks. See Figure 15 for proper mounting example.

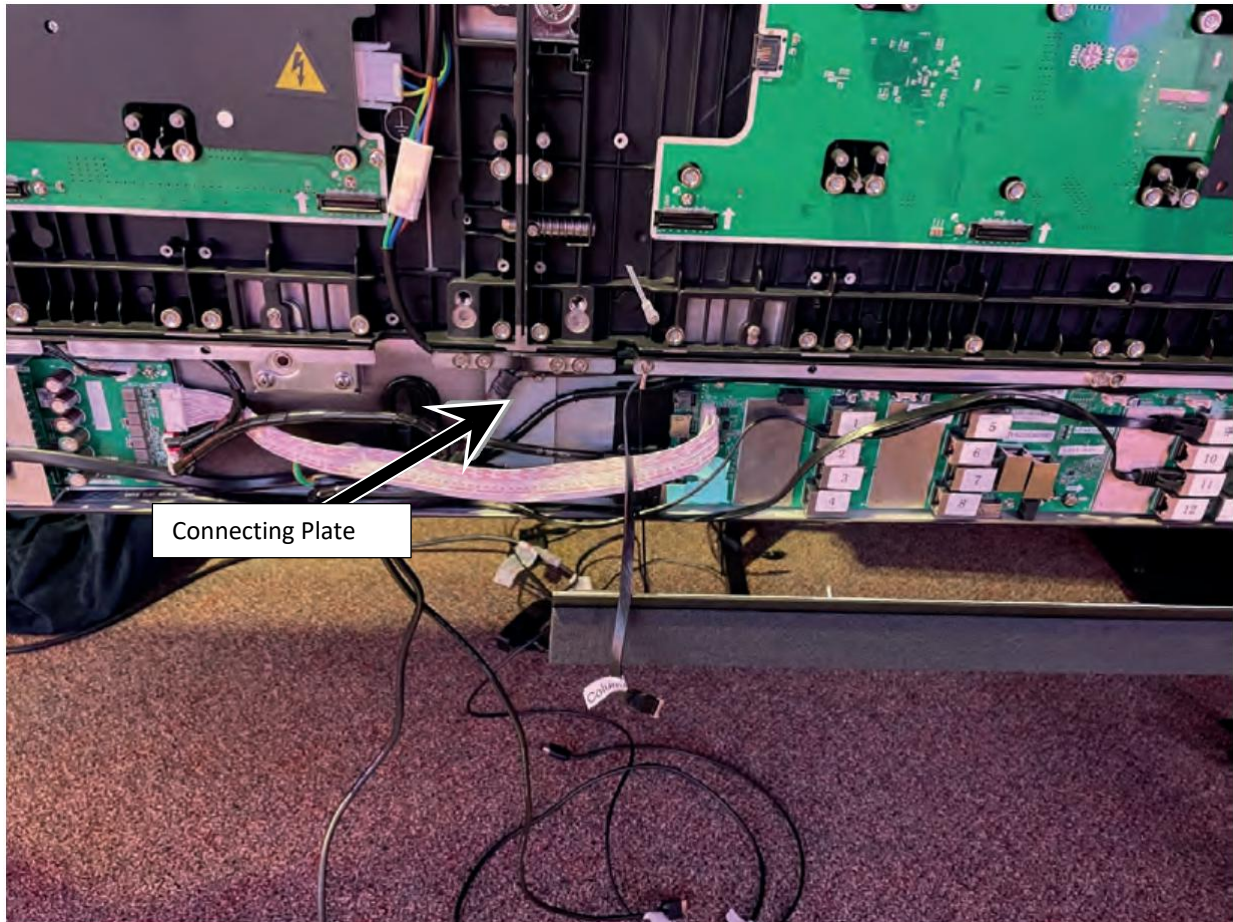

Figure 15

3. Mount the Lower Frame Sound Bar in place beneath the lowest row of panels as shown. The Sound Bar locks in place using rotary hook locks. See Figure 15 for proper mounting example.

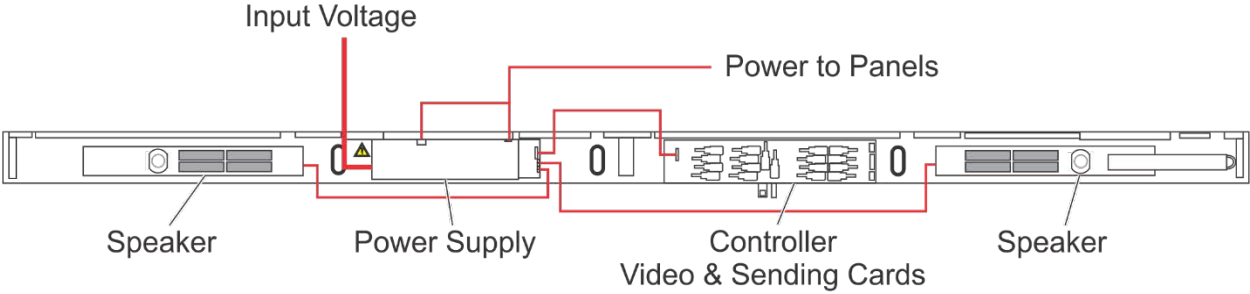

Figure 16: Location of Sound Bar Components & Power Distribution

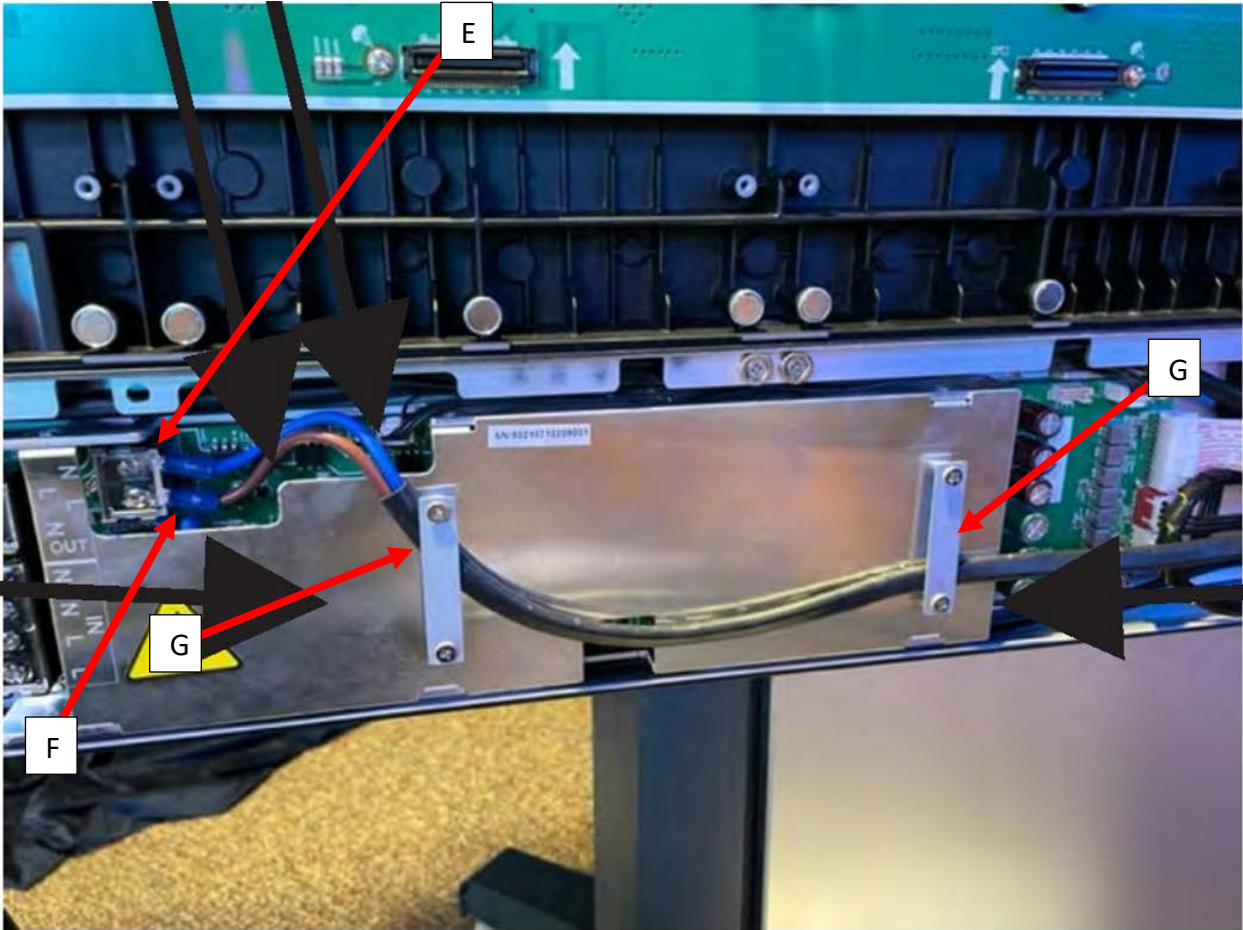

Figure 17

**NOTICE**

Steps 4 through 6 apply to the 120", NLID-20004 model. For the 150", NLID-20008 and the 180", NLID-20009 models, proceed to step 7.

4. Route the Blue (E) and Brown (F) Power Cable from the right lower bar to the left, behind the two plates (G) as shown as shown in Figure 16 and Figure 17. Make the connection as follows.
  - Blue Cable on top
  - Brown Cable on bottom.

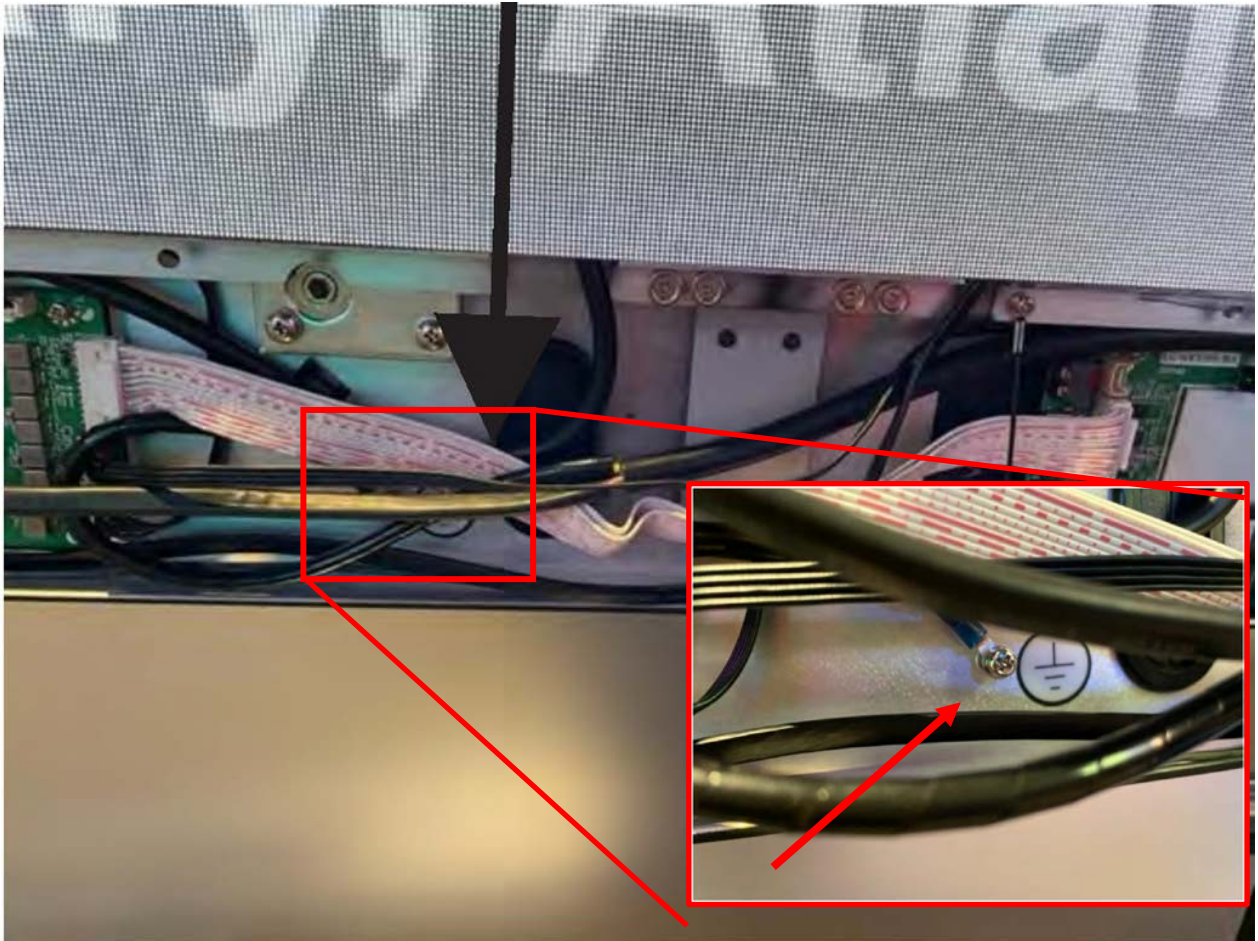

Figure 18

5. Add the grounding cable as shown in Figure 18.

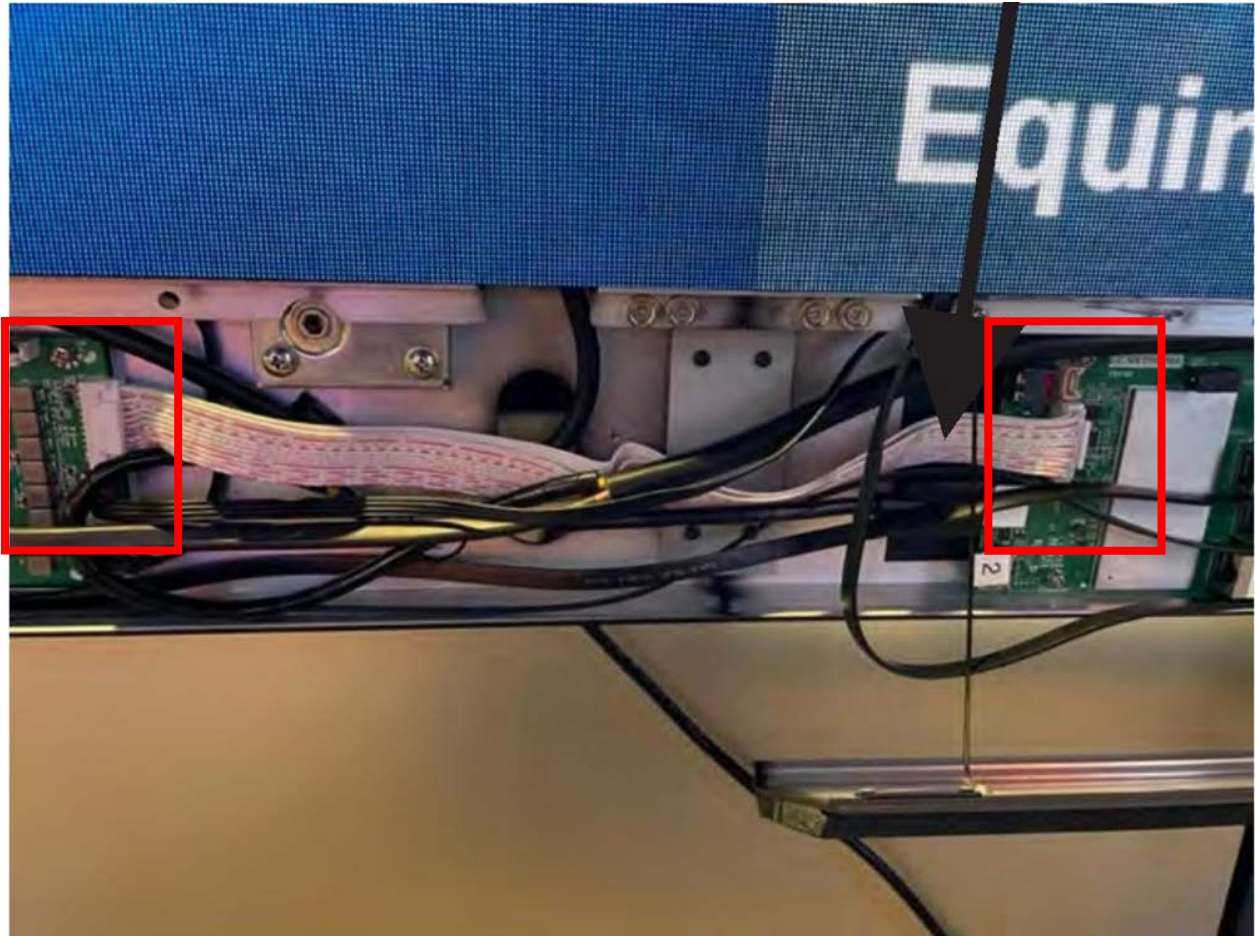

Figure 19

6. Connect the ribbon cable shown in in Figure 16 and Figure 19.

**NOTICE**

The following steps are for the 150", NLID-20008 & 180", NLID-20009 models.

**CAUTION**

**Potential Damage to Equipment.** The Power Cables for the NLID-20008 and NLID-20009 have multiple power cables, one of which ends in a white connector. If these cables are misconnected, the cabinet will not function and the wire will overheat possibly causing damage to the system.

7. Connect the Power Cable cable (J) shown in Figure 20 to plug (K) shown in Figure 21.
8. Connect the Power Cable cable (H) shown in Figure 20 to plug (L) shown in Figure 22.

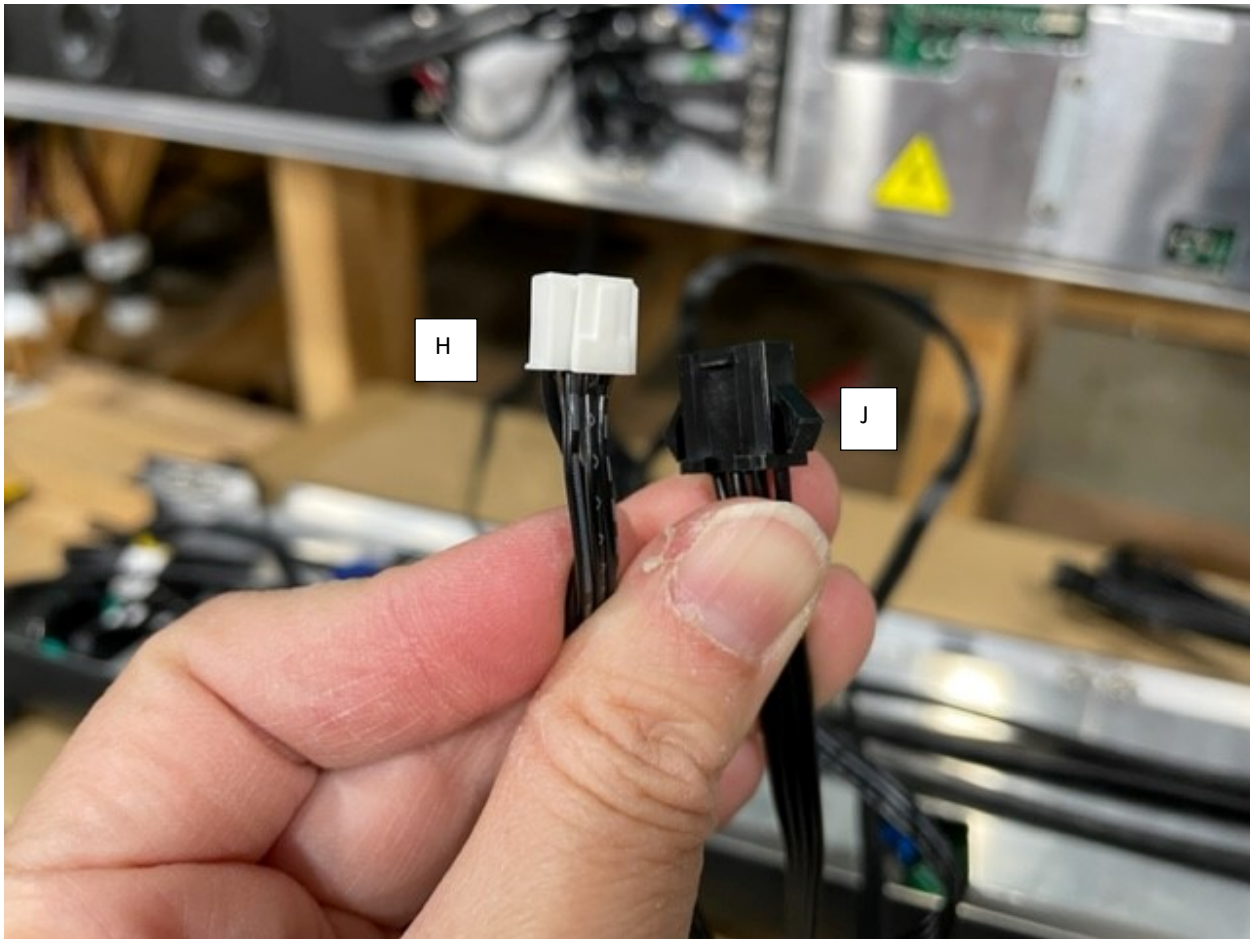

Figure 20



Figure 21



Figure 22



- Secure the columns together by rotating the Side Hook Locks in each panel within each column with a hex wrench until the two adjacent columns are fully locked together (See Figure 23).

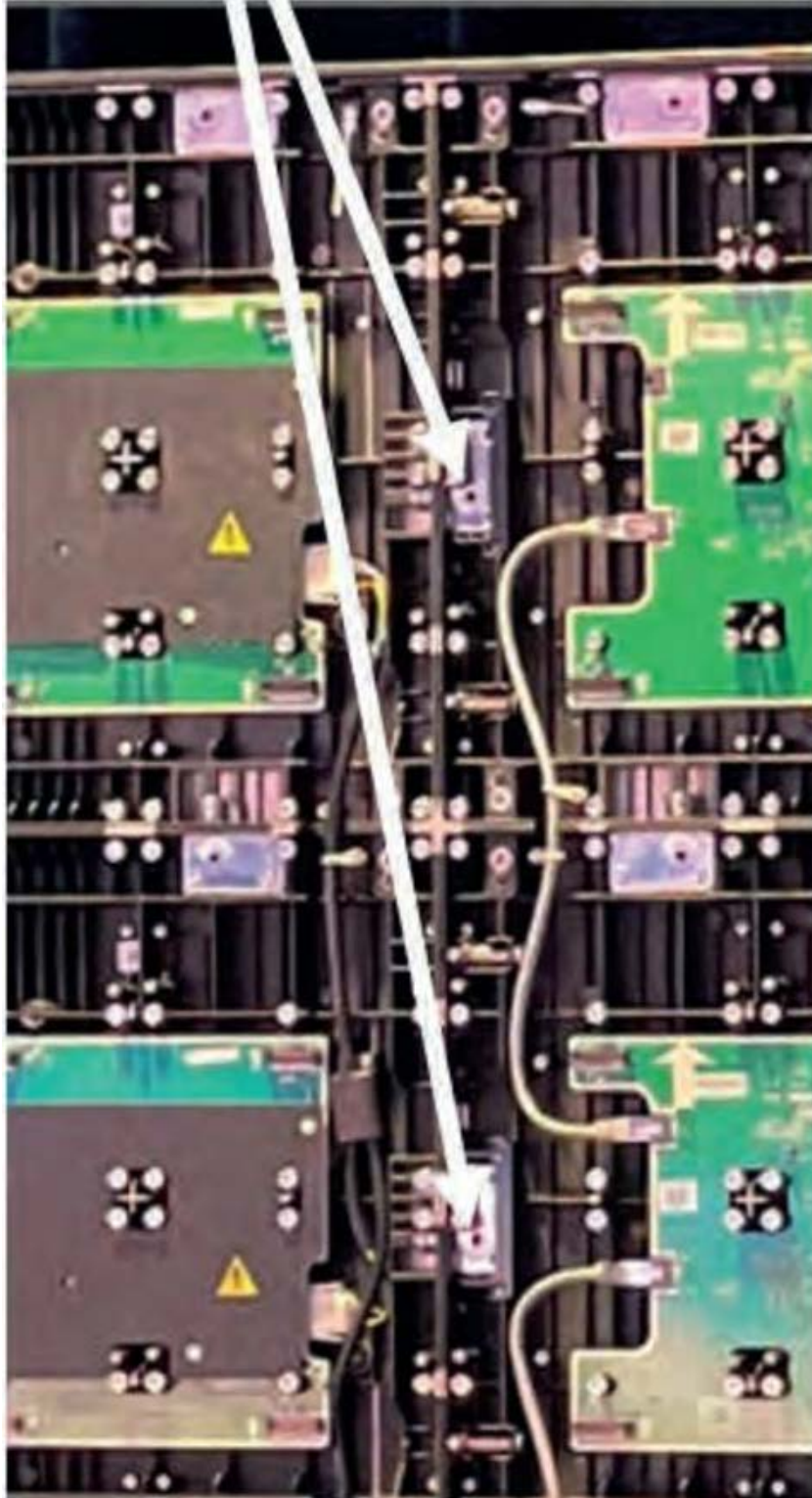

Figure 23

- 10. Connect the Power and Signal (data) cables between the panels as shown in Figure 25. Red indicates a 5-branch power cable and purple indicates a data (network) cable. See Section 5.2.4 for connections on the Sending Card.
- 11. Connect the Signal and Power cables to the Lower Side Frame Assembly. Insert each column of the signal cables into the corresponding columns of sockets according to their respective positions only. Plug in the power cables with 3p plugin connectors according to their respective positions, as illustrated below. Power is delivered to each cabinet as a branch off the main line for each column. All Column power lines connect to the Power Supply.

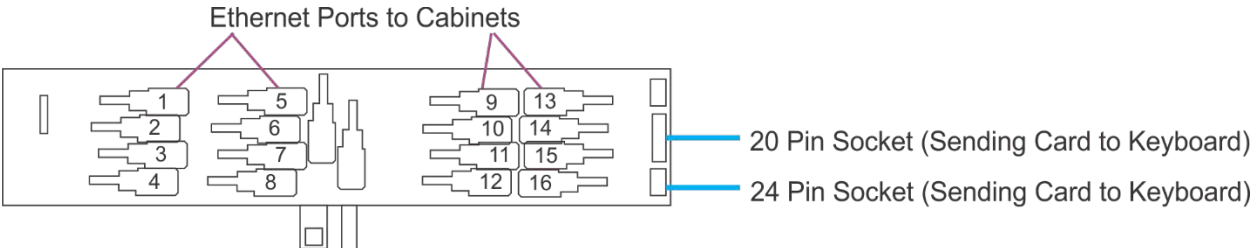

Figure 24: Controller(Sending Card) Connection Ports



Figure 25

5.2.4 Signal Cable Connections

The following provides connections between the individual columns and the Sending Card for the AIO NLID-20004 (120”), NLID-20008 (150”) & NLID-20009 (180”) models

120

Column (right to left)	Primary Connection (Sending Card)	Alternate Connection (Sending Card)
1	13	N/A
2	15	N/A
3	9	N/A
4	11	N/A

150

Column (right to left)	Primary Connection (Sending Card)	Alternate Connection (Sending Card)
1	13	14
2	15	16
3	9	10
4	11	12
5	5	6

180

Column (right to left)	Primary Connection (Sending Card)	Alternate Connection (Sending Card)
1	13	14
2	15	16
3	9	10
4	11	12
5	5	6
6	7	8

### 5.2.5 Install the LED Modules

#### **NOTICE**

*For the purpose of example, the NLID-20004 model is used. When mounting for the NLID-20008 or NLID-20009, make the required adjustments in measurements and equipment.*

Install the modules from left to right, from right to left, from bottom to top or from top to bottom as appropriate for the installation environment on the site. Adjust each module to ensure that they are aligned in all axes (X, Y & Z).



#### **CAUTION**

**Potential Damage to Equipment. Use proper strength and avoid forceful insertion during installation.**

1. Install the modules. The modules shall be hard connected with hub board and the connectos on the modules. See Figure 26 for indexing positions for modules.

#### **NOTICE**

*Each of the panels is delivered with a number marked on the upper right on the inside (see Figure 27), which represents the installation position of the panel at the time of factory correction. Each of the modules is also marked with a number (on the back). For example, in the number 16-5, 16 means the lamp board is installed in panel 16 at the time of factory correction; 5 means the position inside panel 16..*

1-1	1-2	1-3	01*	6-1	6-2	6-3	06*	11-1	11-2	11-3	11*	16-1	16-2	16-3	16*	21-1	21-2	21-3	21*
1-5	1-6	1-7	1-8	6-5	6-6	6-7	6-8	11-5	11-6	11-7	11-8	16-5	16-6	16-7	16-8	21-5	21-6	21-7	21-8
2-1	2-2	2-3	02*	7-1	7-2	7-3	07*	12-1	12-2	12-3	12*	17-1	17-2	17-3	17*	22-1	22-2	22-3	22*
2-5	2-6	2-7	2-8	7-5	7-6	7-7	7-8	12-5	12-6	12-7	12-8	17-5	17-6	17-7	17-8	22-5	22-6	22-7	22-8
3-1	3-2	3-3	03*	8-1	8-2	8-3	08*	13-1	13-2	13-3	13*	18-1	18-2	18-3	18*	23-1	23-2	23-3	23*
3-5	3-6	3-7	3-8	8-5	8-6	8-7	8-8	13-5	13-6	13-7	13-8	18-5	18-6	18-7	18-8	23-5	23-6	23-7	23-8
4-1	4-2	4-3	04*	9-1	9-2	9-3	09*	14-1	14-2	14-3	14*	19-1	19-2	19-3	19*	24-1	24-2	24-3	24*
4-5	4-6	4-7	4-8	9-5	9-6	9-7	9-8	14-5	14-6	14-7	14-8	19-5	19-6	19-7	19-8	24-5	24-6	24-7	24-8
5-1	5-2	5-3	05*	10-1	10-2	10-3	10*	15-1	15-2	15-3	15*	20-1	20-2	20-3	20*	25-1	25-2	25-3	25*
5-5	5-6	5-7	5-8	10-5	10-6	10-7	10-8	15-5	15-6	15-7	15-8	20-5	20-6	20-7	20-8	25-5	25-6	25-7	25-8

Figure 26

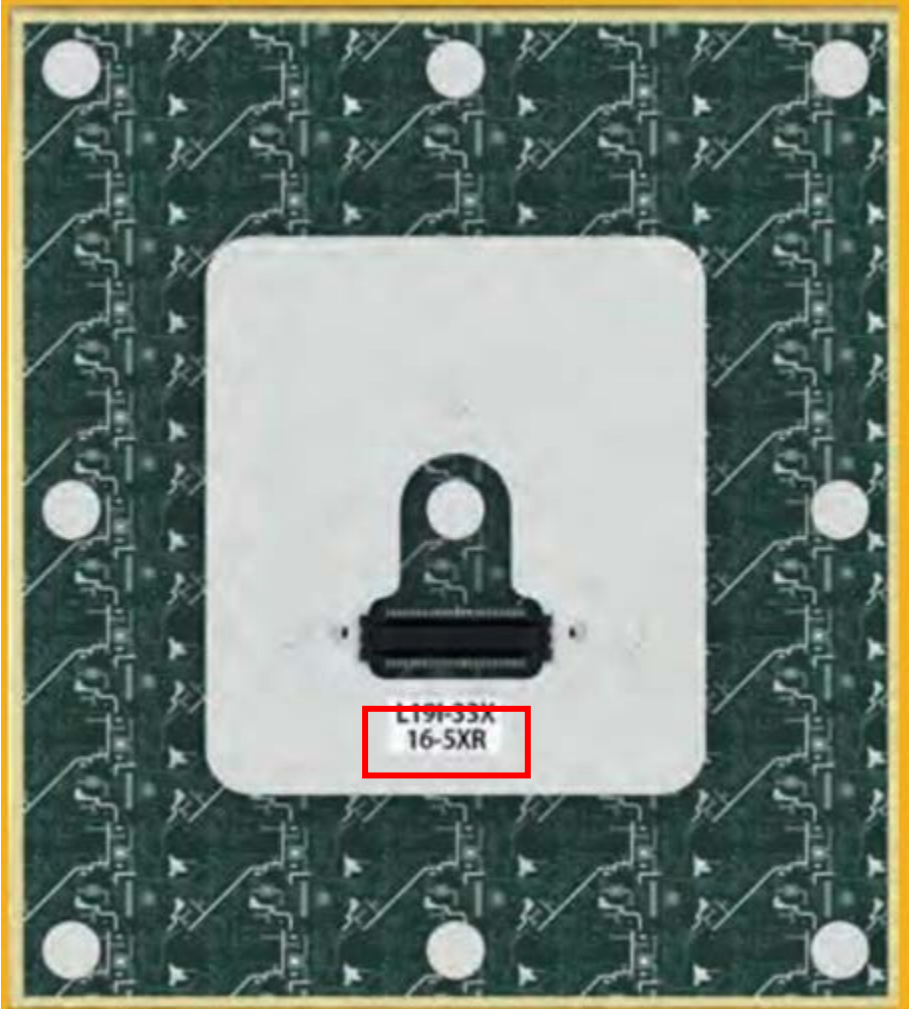

Figure 27

### 5.2.6 Install the Edgings & Frame Covers

1. Install the left and right edgings. The left and right edgings are clipped in the side spring locating pinhole with clips (as previously described, the spring locating pin on the leftmost of the screen should be removed and an edging should be installed), as illustrated in Figure 28:

## NOTICE

*The left and right edgings are marked with the letters "L" and "R" respectively as viewed from the front.*

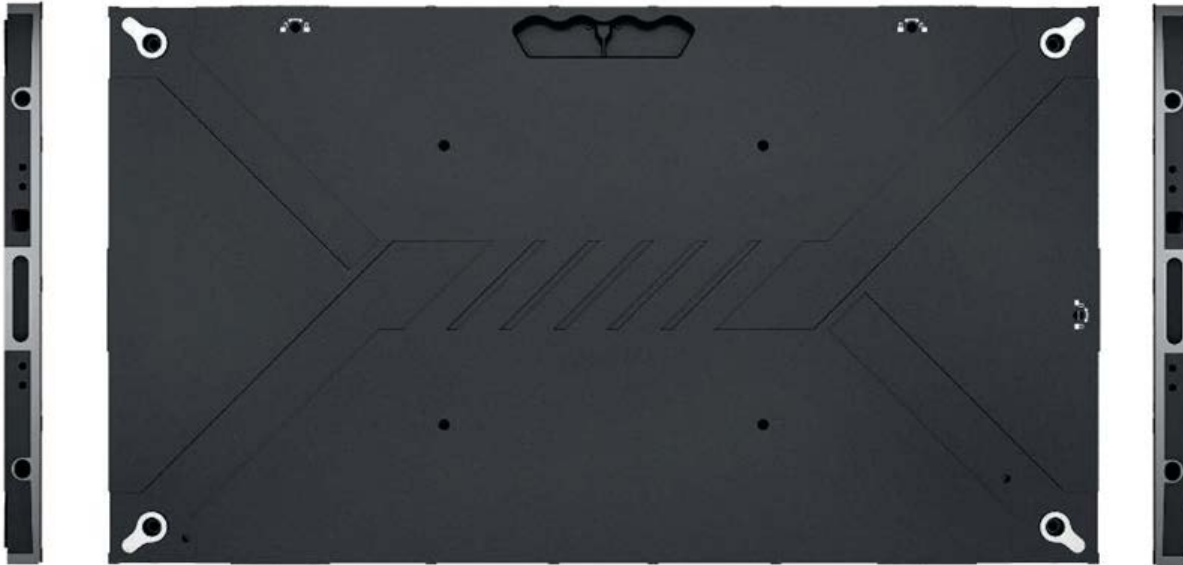

Figure 28

2. Install the lower side frame covers from left to right according to their respective positions indicated on the installation diagram and secure them with a Phillips Head screwdriver and M3x8 black countersunk head screws. The installed covers are as shown in Figure 29.



Figure 29

**NOTICE**

*Under certain conditions, individual LEDs may fail over the first 30 days. Please note, this is not a defect and is considered normal in certain circumstances. If an LED fails, simply replace the module with a spare module and contact NanoLumens technical support for RMA.*





## 6 Functional Description

The Captivate All In One system is a self-contained display. Figure 30 is a block diagram of the display function and can be used to aid in trouble analysis. In addition, the following paragraphs provide a narrative of the operational theory for the display.

### 6.1 Power Supply

The display's primary power source is the Input voltage of 120V<sub>AC</sub>. This Input voltage is processed in the Power Supply which possesses some surge protection and filtration capability. The 120V<sub>AC</sub> is distributed to the multiple cabinets and speakers of the display and also is stepped down and rectified to 5V<sub>DC</sub> for use by the Controller.

### 6.2 Controller

The Controller serves as the display's I/O point which supports HDMI input/output, DP video input/output and 18 Ethernet outputs. The Controller is based on an Android 9.0 operating system and is the LED display control with video processing integration and audio output.

#### 6.2.1 Video Card

The Video Card is part of the Controller and is the primary processing and memory point for the display.

#### 6.2.2 Sending Card

From the Sending Card is the interface between the Controller and the other components of the display. Data is carried to all points of the display via the Ethernet.

### 6.3 Cabinets

Each Cabinet is composed of multiple subcomponents to include a number of Nixels and a control panel which in turn contains a Power Converter, Receiver Card and Hub.

#### 6.3.1 Power Converter

The Power Converter for the cabinet receives 120V<sub>AC</sub> from the main Power Supply and then steps that voltage down and rectifies it to 5V<sub>DC</sub> for use by the components of the cabinet.

#### 6.3.2 Hub

The Hub is connected to the Ethernet network of the display and routes all data for its given cabinet to the Receiver Card while passing all other data along to the next cabinet.

#### 6.3.3 Receiver Card

The Receiver Card processes the instructions from the Sending Card and drives the individual LEDs on each Nixel.

#### 6.3.4 Nixel

The Nixel is a module that contains an array of LEDs and distributes 5V<sub>DC</sub> to each LED as well as the controlling driver signals.

### 6.4 Speakers

---

The Speakers are powered by the 120V<sub>AC</sub> from the Power Supply and are driven by signals from the Sending Card.

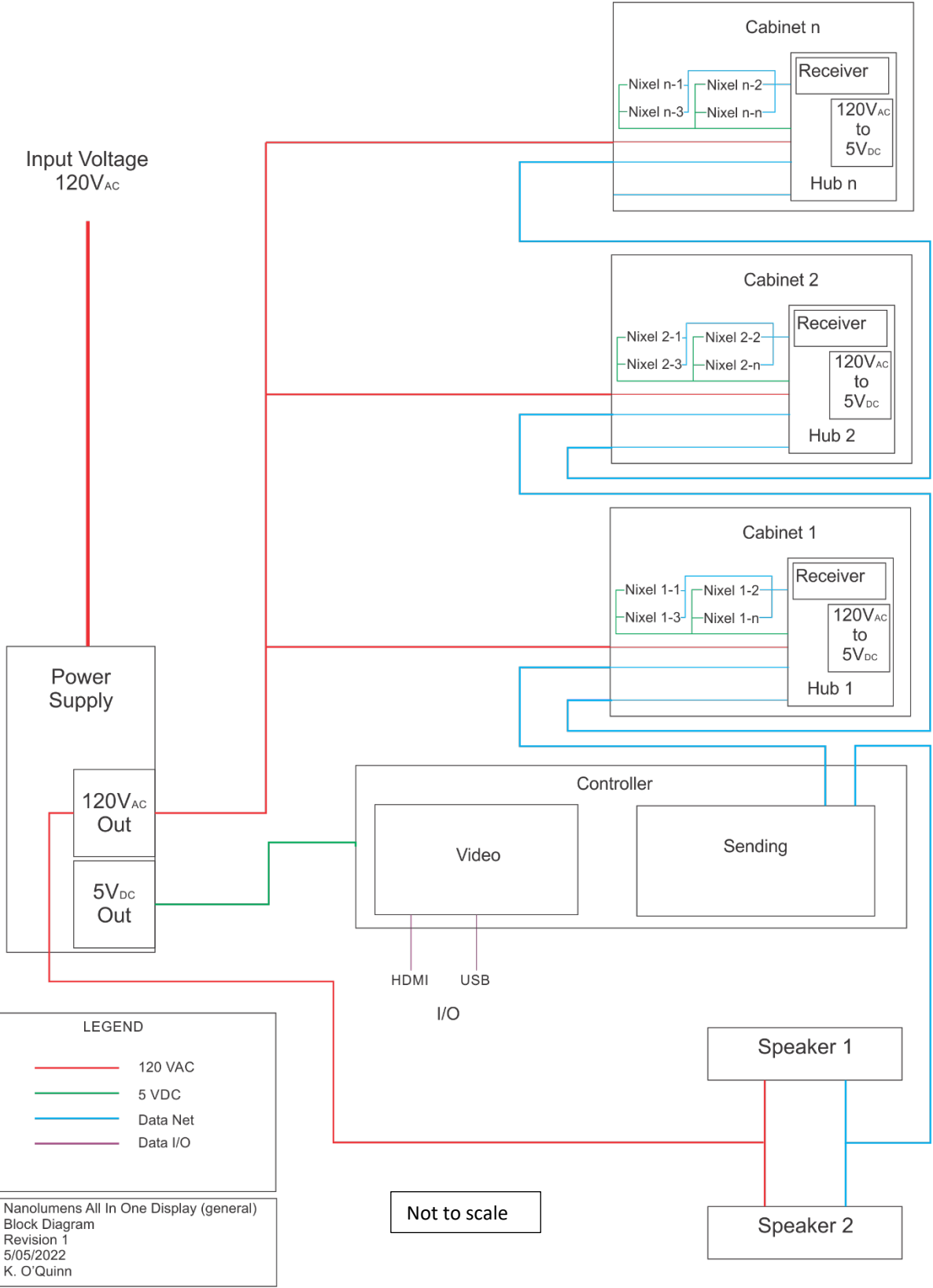

Figure 30

## 7 Troubleshooting

Preliminary troubleshooting for any malfunction of any device should begin with checking for the presence of power and verification of all electrical connections and software settings.



**POTENTIAL FOR ELECTRIC SHOCK. SOME ACTIVITIES IN THE PROCESS OF MALFUNCTION ISOLATION MAY REQUIRE EXPOSURE TO LIVE ELECTRICAL FEEDS. TAKE APPROPRIATE MEASURES TO PREVENT ELECTROCUTION.**



**Potential Damage to Equipment. Some activities in the process of malfunction isolation may require disconnecting and reconnecting equipment. To prevent damage to equipment due to cross circuit, always consult cable labels and terminal markings when making electrical connections..**



*During initial startup, it is common for some modules not to come on immediately. After turning the display on, allow up to 15 minutes before troubleshooting non-responsive modules..*

### 7.1 Simple Troubleshooting

- A. Part of the display doesn't light up after power on.
  1. Verify that the network cable in the panel has good contact.
  2. Verify that the power cable in the panel has good contact.
- B. The indicator doesn't work.
  1. Verify that the power supply is functional;
  2. Verify that the switch of the display is turned on.
- C. No image is displayed after connecting to the computer with an HDMI cable..
  1. Verify that the cable is in an HDMI input;
  2. Verify that the HDMI cable between the machine and the external computer is connected.

### 7.2 Intermediate Troubleshooting

- A. No panels work.
  1. Verify that power is getting to the panels.
    - If not, verify that the Power Supply is working.
    - If the Power Supply is working, check and repair wiring.
    - If Power Supply is not working, replace the Power Supply.
  2. Check to make sure power is getting to the Controller.
    - If not, check and repair wiring.
    - If power is getting to the Controller, replace the Controller.
  3. Replace the Ethernet from the Controller to the first panel.
    - If the display starts to work, then the problem was the Ethernet jumper.
    - If the display still does not work, replace the Controller.

- 
- B. All of or part of a column of panels does not work (others do work)
1. Check to make sure power is getting to the panels. If not, check the wiring.
  2. Check the Ethernet line and connection coming out of the last working panel (or Controller) and going into the first non-working panel. Replace the Ethernet jumper and observe. If the display starts working, the Ethernet jumper was the problem.
  3. Use an Ethernet jumper to bypass the first non-working panel. If the other panels start working, then the problem is in the hub or incoming connection in that skipped panel. Replace the adapter board.
  4. Use an Ethernet jumper to bypass the last working panel. If the non-working panels start working then the problem is in the hub or outgoing connection in the last working panel. Replace that adapter board.

## 8 Servicing and Support

### 8.1 Cleaning

NanoLumens LED displays, are robust, energy efficient and designed to operate 24/7/365, with and anticipated life span to half brightness of 100,000, hours OR 11.5 years of continual use, with basic maintenance. As with most products, lifespans are based upon normal usage, wear and tear and maintenance. A key factor in the longevity of the NanoLumens display is the cleaning and maintenance of the LED face.

Outdoor displays and displays that are installed in certain indoor, industrial environments can be subject to more than the average range contaminants found in most normal indoor environments. If a display is located in an environment which is subject to dust and other airborne contaminants it will require additional care in the form of cleaning on a quarterly or at the very least, a semi-annual basis. Neglecting this maintenance can ultimately effect the longevity of the display.



**Potential Damage to LEDs. Do not apply pressure to LEDs while cleaning.**

The following methods are presented in the order given to minimize physical contact with the LEDs to clean the display. It is not necessary to use all steps. Proceed until the display is clean then stop.

1. Begin with a touch-free use of low-pressure, compressed air. This will remove most of the lighter contaminants without putting pressure on the LEDs.
2. Gently run over each Nixel™ with a microfiber cloth.
3. Use a microfiber cloth to lightly wipe over the display.

### 8.2 Warranty Returns

In the event a situation should arise where field service is not possible, it may be necessary to return merchandise to Nanolumens. The process for doing this is as follows:

1. Contact Nanolumens using the Support Page by filling out the requested information and providing a description of the problem and model of the product. You can additionally supply information via email or by phone as shown on the page.
2. If it is determined that a module must be returned, you will need to supply the serial number(s) of the module(s) to be returned. The serial number can be found on a white label.
3. An RMA will be generated and will be sent to you. Fill out the form and return it in the packaging with the module(s) to be returned.
4. Pack each module individually using bubble wrap or some other cushioning medium to prevent damage to the LED during the packing or shipping process.



*The sender is responsible for the cost of shipment of material to Nanolumens. Nanolumens will assume responsibility for the cost of shipment for repaired or replacement material..*

### 8.3 Replacement of Parts

This section covers the removal and replacement of the Adapter Boards and Modules of a display.



**Potential Damage to Circuits. Always use grounding straps when handling PCBs or other semiconductors. Place PCBs in anti-static containers when not installed or otherwise grounded.**



*If cables are not marked indicating their connection point, it is advised to mark them before disconnecting so that they can be properly reconnected later.*

#### 8.3.1 Adapter Board Removal

1. Locate the faulted panel and remove all modules. Refer to Section 8.3.3 for removal of panels.

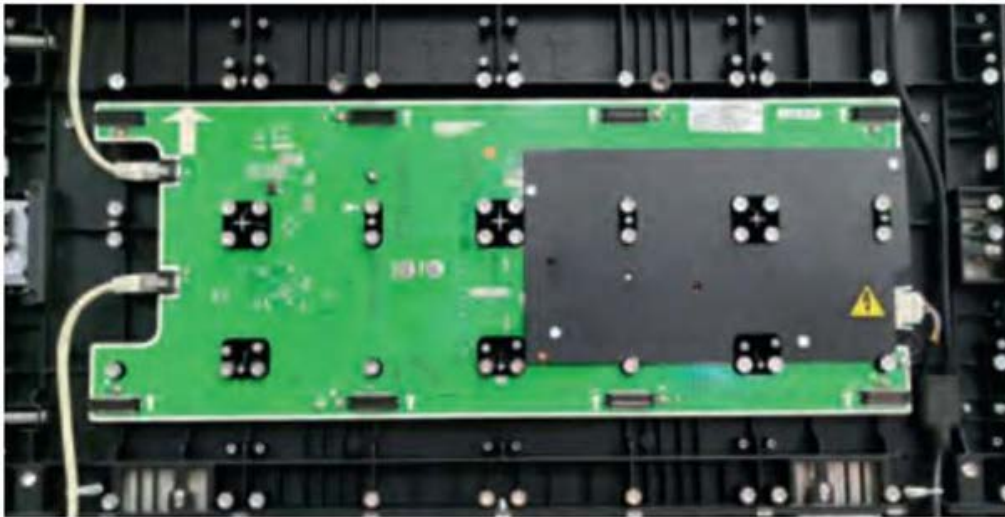

Figure 31



2. Disconnect the power supply and network cables from the 3-in-1 board.

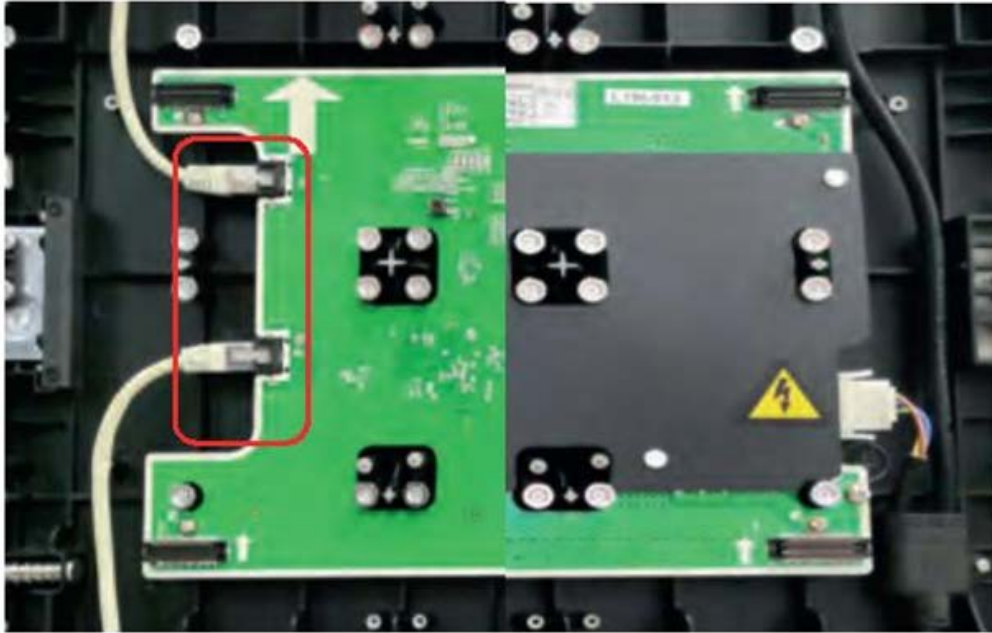

Figure 32

3. Remove the 8 screws on the 3-in-1 board.

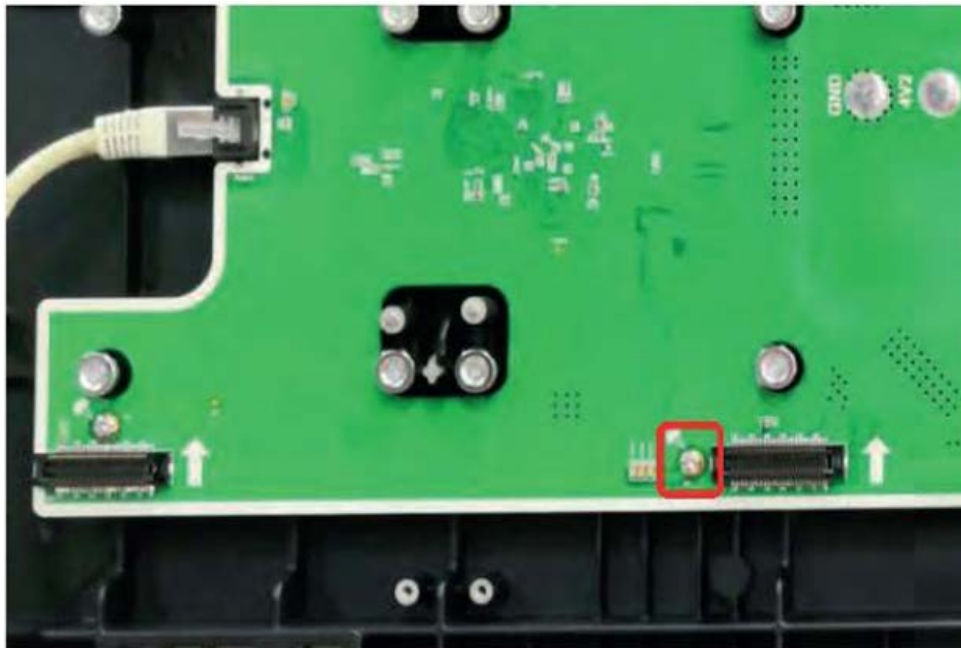

Figure 33

4. Extract the faulted 3-in-1 board and if not to be discarded, store in a static proof bag or other ESD complaint manner.

---

### 8.3.2 Adapter Board Installation

1. Inspect the replacement 3-in-1 board for signs of damage.
2. Orient the replacement 3-in-1 board with respect to the mounting position as shown in Figure 31.
3. Insert the 3-in-1 board with the 8 holes aligned with the 8 mounting points on the panel.
4. Attach the 3-in-1 board with 8 screws as shown in Figure 33. Tighten the screws to fit.
5. Connect the 3-in-1 board to power and the network as shown in Figure 32. Consult cable labels and terminal markings when making electrical connections.

## 8.3.3 Module Removal



**Potential Damage to LEDs. LEDs are fragile and can easily be damage Handle Modules with care at all times.**



*Modules are held in place by attractive magnetic forces. No additional fasteners or excessive force is required to remove or install them.*

1. Locate the faulted module and attach the side bevel of the pre-maintenance tool right below the module as shown in Figure 34.



Figure 34

- 2. Detach the module by slowly rotating the pre-maintenance tool from the curved plane to the bottom plane. Extract the module by withdrawing it straight from the mounting position. Use a free hand to hold the module as it is extracted. See Figure 35.



Figure 35

3. Extract the module by holding it with one hand and rotate the maintenance tool off the module as shown in Figure 36



Figure 36

**NOTICE**

*The anti-static wrapping used in shipping is adhered to the inside of the shipping box and will not come out unless forced. Do not remove the anti-static wrapping. Failure to properly package Nixels may result in warranty being voided.*

4. Package the anti-static wrapped Nixel board in a box with interior cushioning to absorb any external shock as shown in Figure 37.
5. Tape the boxes in groups of 5 or less and place the return label on the top box. See Figure 38



Figure 37



Figure 38

## 8.3.4 Module Installation



**Potential Damage to LEDs. LEDs are fragile and can easily be damage Handle Modules with care at all times.**



*Modules are held in place by attractive magnetic forces. No additional fasteners or excessive force is required to remove or install them.*

1. Remove the module from the anti-static packaging and inspect the module for signs of damage.
2. Attach the module to the pre-maintenance tool by holding it with one hand and attach the side bevel of the pre-maintenance tool right below the module as shown in Figure 39.



Figure 39

- 3. Orient the module with the receiving section of the panel so that the arrows shown in Figure 40 are pointed in the same direction..

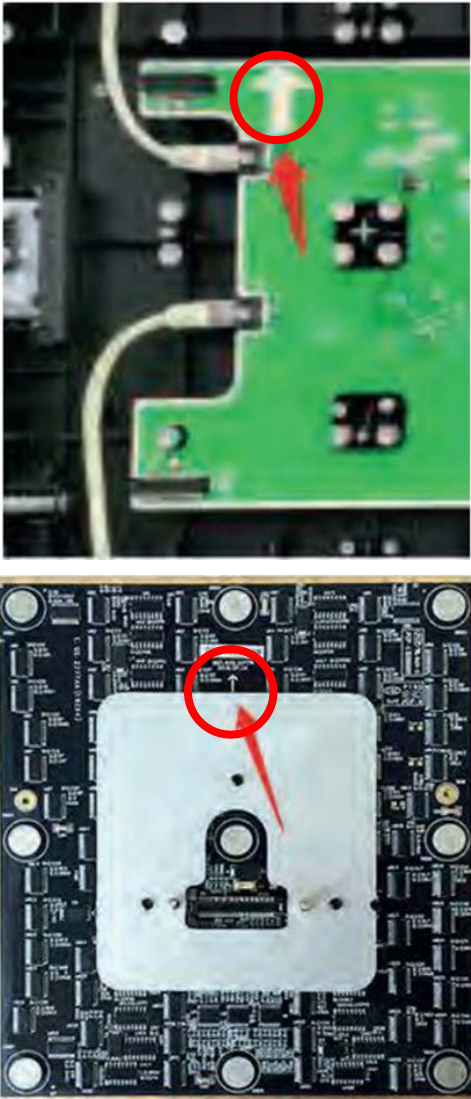

Figure 40



- 4. Attach the module by inserting it squarely into its position until it is in place. Then slowly rotating the pre-maintenance tool from the curved plane to the bottom plane. Use a free hand to hold the module as the tool is disengaged. See Figure 41.



Figure 41

---

## 9 Acknowledgements

### 9.1 General

All texts and pictures contained herein are provided for information only. None of them shall be construed as any commitment in any form.

The appearance design of this product is subject to further improvement or modification without notice.

Note: HDMI, HDMI HIGH-DEFINITION MULTIMEDIA INTERFACE, and the HDMI logo are trademarks or registered trademarks of HDMI Licensing LLC in the United States and other countries.

### 9.2 IPR Declaration:

All hardware designs and software programs related to this product are protected by copyright laws. No part of this product or this installation manual may be reproduced unless with our prior authorization.

### 9.3 About NanoLumens

Working with leading Fortune 500 clients on five continents, NanoLumens continues to pioneer visualization solutions.

The company is creating a market where clients can have leading-edge technology, and access to choices that include managed, brilliant content, current information streams and even interactive customer experiences tailored to a specific industry. This innovation is driven by increasing customer

demand. NanoLumens provides an immersive experience that shatters any previous modes of customer engagement.

All NanoLumens solutions are designed and made in the United States of America.

[www.nanolumens.com](http://www.nanolumens.com)